

EVOCHAIN[®]

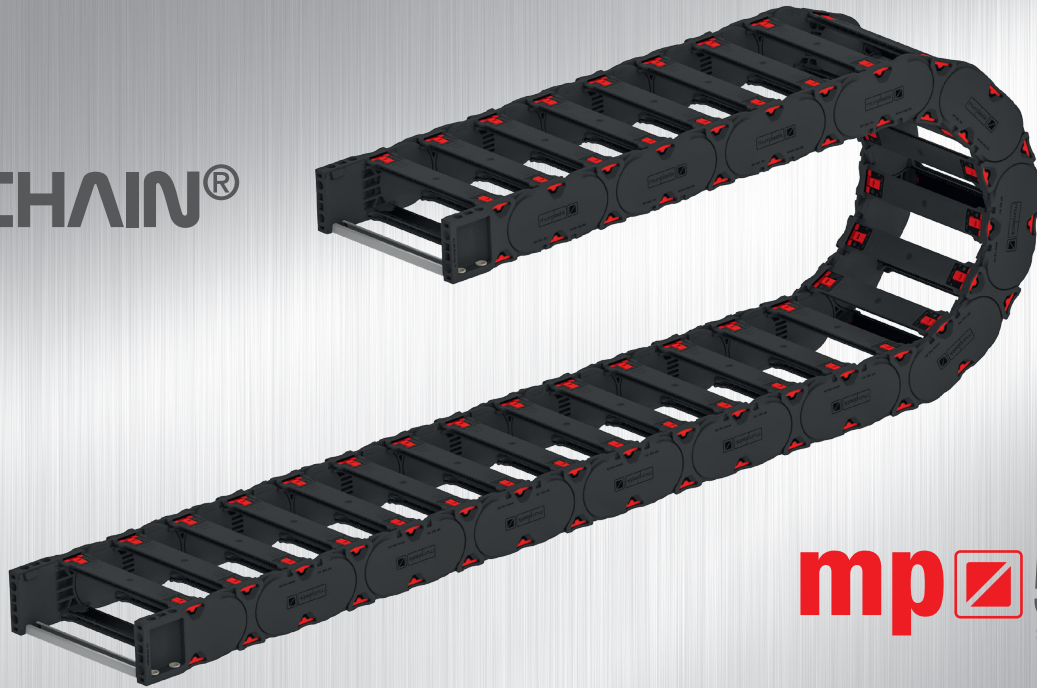

mp  **560**
EVOCHAIN

Energy chain systems



MP 560

OPEN



- EASY TO ASSEMBLE WITH THE **EVOLOCK®** CROSSBAR LOCK SYSTEM
- FAST TOOL-FREE OPENING AND CLOSING OF THE SHELVING SYSTEM IN THE INSIDE AND OUTSIDE BEND WITH THE **EVORACK®** SHELF SUPPORT
- EXTREMELY DURABLE **EVOSILENCE®** NOISE DAMPING SYSTEM IN THE CHAIN LINK WITH A SPECIALLY DEVELOPED TPE
- QUIET AND LOW-VIBRATION UNROLLING WITH THE **EVOSHOX®** DAMPING SHOE
- GREATLY EXTENDED SERVICE LIFE WITH THE **EVOCONTROL®** GLIDING SHOE WITH INTEGRATED WEAR CONTROL INDICATOR
- PARTICULARLY HIGH SERVICE LIFE FOR APPLICATIONS WITH LATERAL ACCELERATION

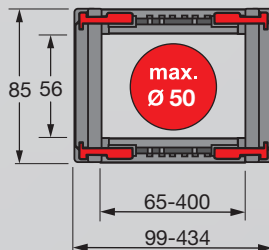

TECHNICAL DATA

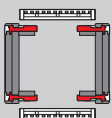

Loading side
Inside and outside bend

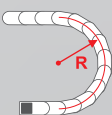

Available radii
135,0 – 500,0 mm



Available interior widths
With plastic crossbar
65,0 – 400,0 mm

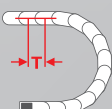

Pitch
T = 91,0 mm

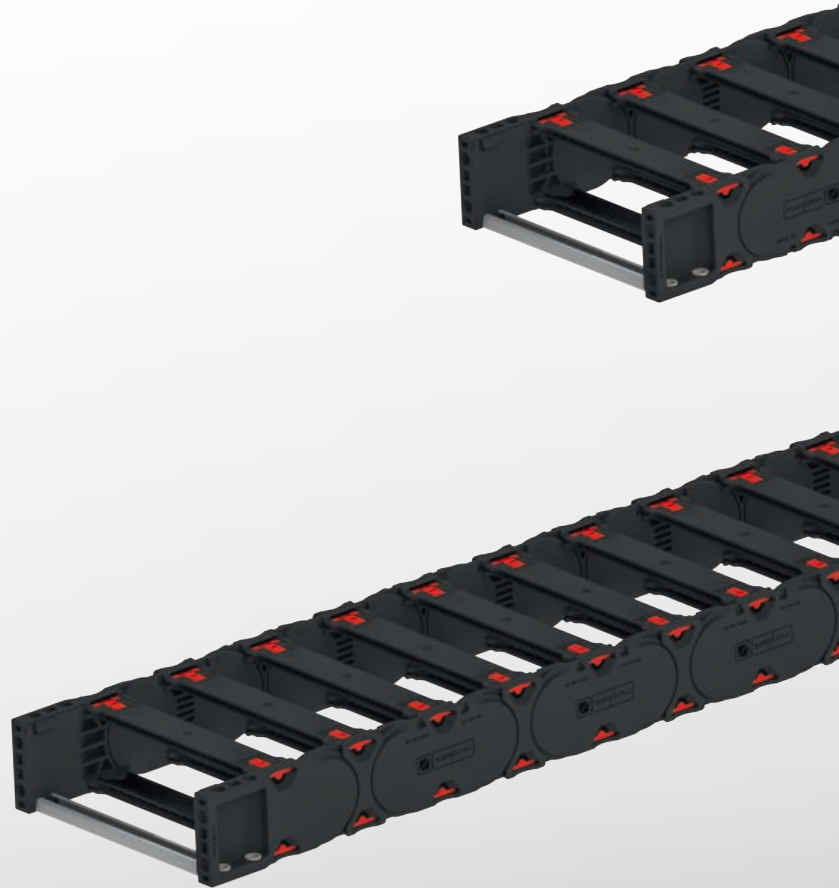

EVOSILENCE®
Noise damping in side link
Noise reduction of up to 10 dB(A) with damping elements in the chain links.



EVOSHOX®
Damping shoe
Noise reduction of up to 25 dB(A) in combination with the noise damping in the chain link.



TECHNICAL SPECIFICATION

Travel distance gliding L_g max.	150.0 m
Travel distance self-supporting L_r max.	10.0 m
Travel distance vertical hanging L_{vh} max.	100.0 m
Travel distance vertical upright L_{vs} max.	6.0 m
90° rotated unsupported L_{90r} max.	2.0 m
Speed gliding V_g max.	10.0 m/s
Speed, self-supporting V_f max.	20.0 m/s
Acceleration, gliding a_g max.	50.0 m/s ²
Acceleration self-supporting a_s max.	200.0 m/s ²

Contact our engineering department to meet any higher requirements: efk@murrplastik.de

MATERIAL CHARACTERISTICS

Standard material	Polyamide (PA) black
Service temperature	-30.0 – 120.0 °C
Gliding friction factor	0.3
Static friction factor	0.45
Fire classification	UL 94 HB

Other material characteristics on request.

ADDITIONAL INFORMATION MATERIAL

On our YouTube channel we provide video material on the topics of function, assembly and disassembly.

<https://www.youtube.com/user/MurrplastikTV>



ACCESSORIES

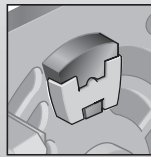

Damping element
in side link
EVOSILENCE®

CROSSBAR LOCK



Crossbar lock
EVOLOCK®

SHELVING SYSTEM



Separator TR

GUIDE CHANNELS



VAW steel galvanised /
stainless steel

STRAIN RELIEF

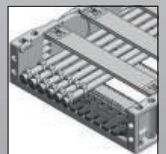

Strain relief ZL-C

CHAIN BRACKET

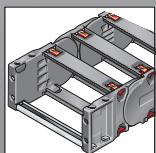

Chain bracket flexible

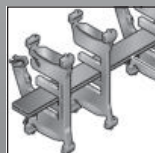

Shelving system RS
EVORACK®

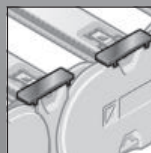

Gliding shoe
EVOCONTROL®

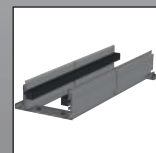

VAW aluminium

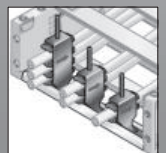

Steel Fix STF

ORDERING KEY

Dimensions in mm [US inch]

Type code	Variant	Inside width	Outside width	Inside width	Outside width	Radius	Crossbar variant	Material	Chain length
0560 30	MP 560 open Crossbar on outside bend Crossbar on inside bend To be opened from inside and outside bend	065 [2.56]	099 [3.90]	300 [11.81]	334 [13.15]	135 [5.31]	0 Plastic full-ridged with bias (RV)	2 Polyamide without damper (PA/black)	
		075 [2.95]	109 [4.29]	312 [12.28]	346 [13.62]				
		087 [3.43]	121 [4.76]	325 [12.80]	359 [14.13]	150 [5.91]	1 Plastic full-ridged without bias (RK)	3 Polyamide with damper (PA/black)	
		100 [3.94]	134 [5.28]	337 [13.27]	371 [14.61]				
		112 [4.41]	146 [5.75]	350 [13.78]	384 [15.12]	175 [6.89]	2 Plastic half-ridged with bias (RV)	9 Special version (on request)	
		125 [4.92]	159 [6.26]	362 [14.25]	396 [15.59]				
		137 [5.39]	171 [6.73]	375 [14.67]	409 [16.10]	200 [7.87]	3 Plastic half-ridged without bias (RK)		
		150 [5.91]	184 [7.24]	387 [15.24]	421 [16.57]				
		162 [6.38]	196 [7.72]	400 [15.75]	434 [17.09]	240 [9.45]	9 Special version (on request)		
		169 [6.65]	203 [7.99]						
		175 [6.89]	209 [8.23]			250 [9.84]			
		182 [7.17]	216 [8.50]						
		187 [7.36]	221 [8.70]			300 [11.81]			
		200 [7.87]	234 [9.21]						
		207 [8.15]	241 [9.49]			350 [13.78]			
		212 [8.35]	246 [9.69]						
		225 [8.862]	259 [10.20]			400 [15.75]			
		237 [9.33]	271 [10.67]						
		250 [9.84]	284 [11.18]			450 [17.72]			
		262 [10.31]	296 [11.65]						
		275 [10.83]	309 [12.17]			500 [19.69]			
		287 [11.30]	321 [12.64]						

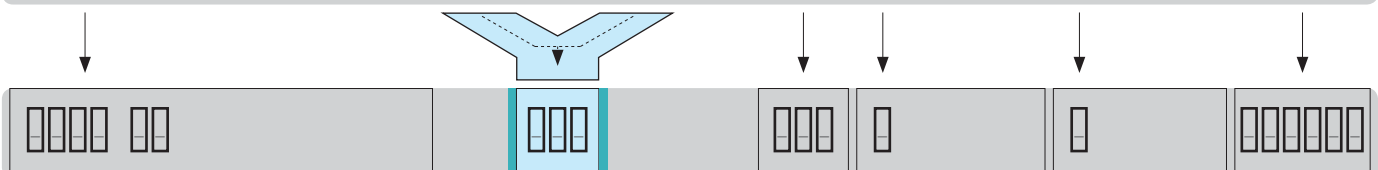

ORDERING EXAMPLE: 0560 30 200 175 0 2 1365

Crossbar on outside bend, crossbar on inside bend, to be opened from inside and outside bend
 Inside width 200 mm, Radius 175 mm
 Plastic crossbar, full-ridged with bias, material polyamide without damper (PA/black)
 Chain length 1365 mm (15 links)

SELF-SUPPORTING LENGTH

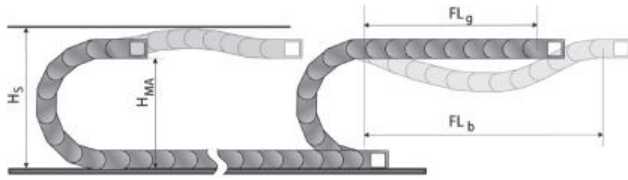

The self-supporting length is the distance between the chain bracket on the moving end and the start of the chain arc.
The installation variant FL_g offers the lowest load and wear for the energy chain.
The maximum travel parameters (speed and acceleration) can be applied for this variant.

- H_S = Installation height plus safety
- H_{MA} = Height of moving end bracket
- FL_g = Self-supporting length, upper run straight
- FL_b = Self-supporting length, upper run bent

LOAD DIAGRAM FOR SELF-SUPPORTING APPLICATIONS

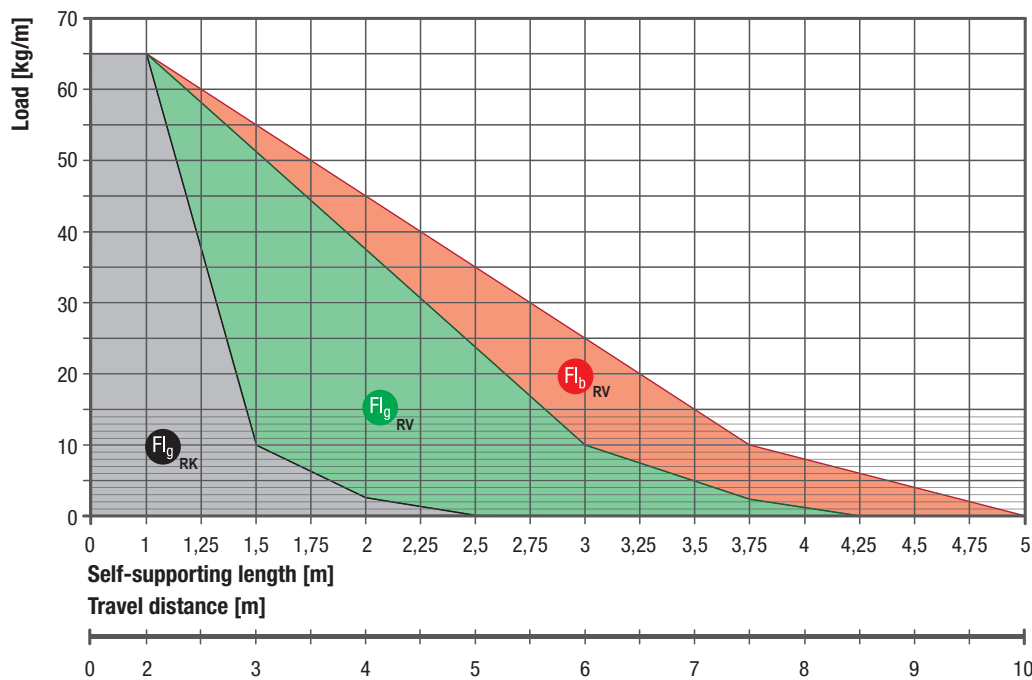

FL_g Self-supporting length, upper run straight

In the FL_g range, the chain upper run still has a bias, is straight or has a maximum sag of 70.0 mm.

FL_b Self-supporting length, upper run bent

In the FL_b range, the chain upper run has a sag of more than 70.0 mm, but still less than the maximum sag of 140.0 mm.

Where the sag is greater than that permitted in the FL_b range, the application is critical and should be avoided. The self-supporting length can be optimised by using a support for the upper run or a more stable energy chain.

DETERMINING THE CHAIN LENGTH

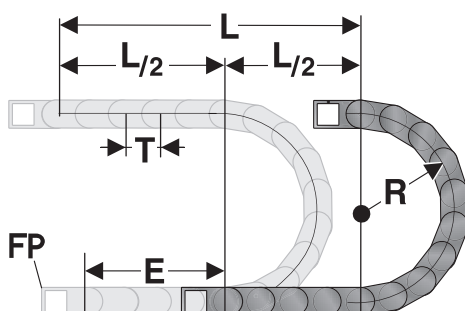

The fixed point of the energy chain should be placed in the middle of the travel distance.
This arrangement gives the shortest connection between the fixed point (FP) and the moving consumer and thus the most efficient chain length.

Chain length calculation = $L/2 + \pi * R + E$
1 m chain = 11 links, 91.0 mm each

- E = Distance between entry point and middle of travel distance
- L = Travel distance
- R = Radius
- T = Pitch 91,0 mm

INSTALLATION DIMENSIONS

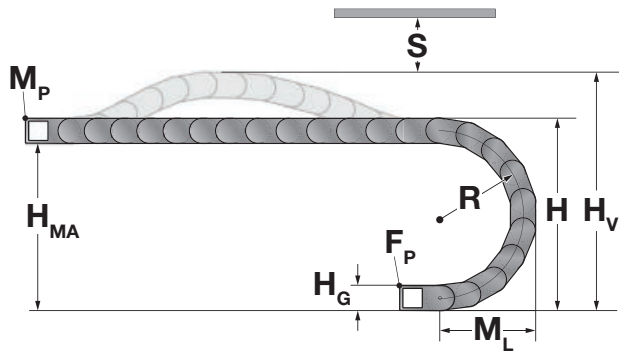

The installation dimensions are differentiated between applications without and with EVOSILENCE® damping elements. Due to their mode of functioning, the damping elements increase the installation height by 25 mm.

For self-supporting applications:

The moving end chain bracket is to be screw fixed at height H_{MA} for the respective radius. The pendular chain bracket is used as standard. For high acceleration values, we recommend the use of a one-sided pivotable moving end bracket, which is fixed 50 mm higher than the pendular chain bracket.

Concerning the installed dimensions, it has to be differentiated whether the chain links are equipped with or without bias: For chain links without bias, the “installed height (H) without bias” has to be taken into account. If the chain links are equipped with a bias, the “installed height (H_V) with increase due to bias” has to be taken into account. In both cases we recommend to include a safety margin S of 20 mm.

For standing or hanging applications:

The moving end chain bracket is to be screw fixed at height H_{MA} for the respective radius. The chain bracket which is pivotable on one side is used as standard. The chain links are without bias, therefore the “installed height (H) without bias” has to be taken into account.

Energy chain without damping element

Radius R	135	150	175	200	240	250	300	350	400	450	500
Outside height of chain link (H_G)	85	85	85	85	85	85	85	85	85	85	85
Height of moving end bracket (H_{MA}) for KA pendular	270	300	350	400	480	500	600	700	800	900	1000
Height of moving end bracket (H_{MA}) for KA pivotable on one side	320	350	400	450	530	550	650	750	850	950	1050
Increase due to bias (V) for 3,0 kg/m workload	60	60	60	60	60	60	60	60	60	60	60
Installation height (H_V) with increase due to bias	415	445	495	545	625	645	745	845	945	1045	1145
Installation height (H) without bias	355	385	435	485	565	585	685	785	885	985	1085
Arc projection ($M_L = H_G/2 + \text{Radius} + \text{Pitch}$)	269	284	309	334	374	384	434	484	534	584	634

Energy chain with EVOSILENCE® damping element

Radius R	135	150	175	200	240	250	300	350	400	450	500
Outside height of chain link (H_G)	85	85	85	85	85	85	85	85	85	85	85
Height of moving end bracket (H_{MA}) for KA pendular	270	300	350	400	480	500	600	700	800	900	1000
Height of moving end bracket (H_{MA}) for KA pivotable on one side	320	350	400	450	530	550	650	750	850	950	1050
Increase due to bias (V) for 3,0 kg/m workload	60	60	60	60	60	60	60	60	60	60	60
Increase due to damper for 3,0 kg/m workload	25	25	25	25	25	25	25	25	25	25	25
Installation height (H_V) with increase due to bias and damper	440	470	520	570	650	670	770	870	970	1070	1170
Installation height (H) without bias, with increase due to damper	380	410	460	510	590	610	710	810	910	1010	1110
Arc projection ($M_L = H_G/2 + \text{Radius} + \text{Pitch}$)	269	284	309	334	374	384	434	484	534	584	634

FLEXIBLE CHAIN BRACKET KA 560

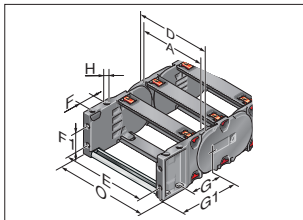

Flexible chain bracket KA 560

This chain bracket offers universal connection options (top, bottom and front) and is attached to the ends of the energy chain. This allows the chain to move right up to the bracket.

If the number of chain links is even, each energy chain requires one male and one female bracket. If the number of chain links is uneven, each energy chain requires two female brackets. At the moving end there is always a female bracket.

M8 bolts are used to secure the brackets in place. Press-in metal bushes with either a through-hole (-FB) or a threaded hole (-FG) ensure the permanent and high-strength transmission of even extreme forces onto the energy chain.

Optionally the chain bracket can be equipped with C-rail and strain relief ZL-C or with bow clamps type STF MP.

Type	Order No.	Material	Inside width A mm	D mm	E mm	F mm	F1 mm	G mm	G1 mm	H mm	H0 mm	KA outside width O mm
KA 560-FB female, complete	0560000050	Plastic	65.0-400.0	A+34,0	A+23,0	35.0	45.0	80.0	135.0		9	A+40,0
KA 560-FB female, pendular, complete	0560000056	Plastic	65.0-400.0	A+34,0	A+23,0	35.0	45.0	80.0	135.0		9	A+40,0
KA 560-FB male, complete	0560000051	Plastic	65.0-400.0	A+34,0	A+23,0	35.0	45.0	80.0	135.0		9	A+40,0
KA 560-FG female, complete	0560000053	Plastic	65.0-400.0	A+34,0	A+23,0	35.0	45.0	80.0	135.0	M8		A+40,0
KA 560-FG female, pendular, complete	0560000055	Plastic	65.0-400.0	A+34,0	A+23,0	35.0	45.0	80.0	135.0	M8		A+40,0
KA 560-FG male, complete	0560000054	Plastic	65.0-400.0	A+34,0	A+23,0	35.0	45.0	80.0	135.0	M8		A+40,0

ASSEMBLY INSTRUCTION FLEXIBLE CHAIN BRACKET FB/FG

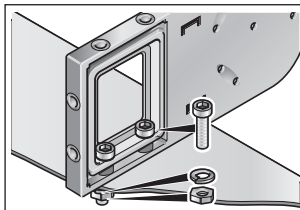

Chain bracket FB

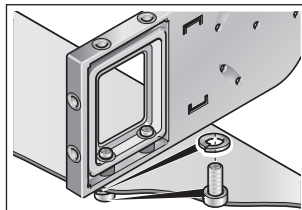

Chain bracket FG

Metal bushings guarantee long-lasting fastening without cold flow in the plastic.

Type KA-FB:

Integrated through-hole is fastened using screw and nut.

Type KA-FG:

Built-in threads allow for quick and easy on-site mounting, since a screw, including a retaining washer where necessary, is sufficient.

LOWERED FIXING POINT MP 560

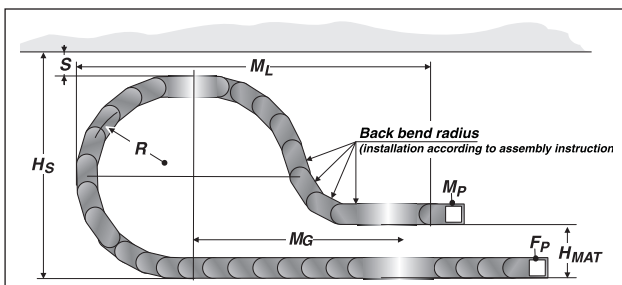

For gliding applications from a radius of 175 mm it is necessary to lower the moving end bracket.

In this case the majority of the links in the table must be added to the calculated chain length.

The rearward chain link is mounted as second chain link after the pendular moving end bracket.

Please contact our application engineers.

Radius R mm	Height of moving end bracket (H _{MAT}) mm	Safety margin (S) mm	Installation height incl. safety (H _S) mm	Projection (M _L) mm	Additional links pcs.	of which additional rearward chain links pcs.
175	250	50	485	673	8	1
200	250	50	535	789	10	1
240	250	50	615	920	12	1
250	250	50	635	930	12	1
300	300	50	735	980	13	1
350	300	50	835	1212	17	1
400	300	50	935	1444	21	1
450	300	50	1035	1585	24	1
500	300	50	1135	1817	28	1

MP 560 OPEN

PLASTIC CROSSBAR EVOLINE



Crossbar

The crossbars connect the two side runs of the energy chain. The crossbar length is equivalent to the inside width of the energy chain.

Type	Order No.	Description	Inside width mm
RS 065-50	050000006500	Crossbar	65.0
RS 075-50	050000007500	Crossbar	75.0
RS 087-50	050000008700	Crossbar	87.0
RS 100-50	050000010000	Crossbar	100.0
RS 112-50	050000011200	Crossbar	112.0
RS 125-50	050000012500	Crossbar	125.0
RS 137-50	050000013700	Crossbar	137.0
RS 150-50	050000015000	Crossbar	150.0
RS 162-50	050000016200	Crossbar	162.0
RS 169-50	050000016900	Crossbar	169.0
RS 175-50	050000017500	Crossbar	175.0
RS 182-50	050000018200	Crossbar	182.0
RS 187-50	050000018700	Crossbar	187.0
RS 200-50	050000020000	Crossbar	200.0
RS 207-50	050000020700	Crossbar	207.0
RS 212-50	050000021200	Crossbar	212.0
RS 225-50	050000022500	Crossbar	225.0
RS 237-50	050000023700	Crossbar	237.0
RS 250-50	050000025000	Crossbar	250.0
RS 262-50	050000026200	Crossbar	262.0
RS 275-50	050000027500	Crossbar	275.0
RS 287-50	050000028700	Crossbar	287.0
RS 300-50	050000030000	Crossbar	300.0
RS 312-50	050000031200	Crossbar	312.0
RS 325-50	050000032500	Crossbar	325.0
RS 337-50	050000033700	Crossbar	337.0
RS 350-50	050000035000	Crossbar	350.0
RS 362-50	050000036200	Crossbar	362.0
RS 375-50	050000037500	Crossbar	375.0
RS 387-50	050000038700	Crossbar	387.0
RS 400-50	050000040000	Crossbar	400.0

EVOLOCK® CROSSBAR LOCK RS 560



Crossbar lock

The EVOLOCK® crossbar lock allows an extremely easy and quick opening and locking of the crossbars due to the innovative locking slide.

Type	Order No.	Colour
RS-560 lock, red	056000004270	RAL 3020
RS-560 lock, blue	056000004271	RAL 5015
RS-560 lock, black	056000004272	RAL 9005

EVOCONTROL® GLIDING SHOE GS 560



Gliding shoe in inside bend

Gliding shoes are used in a horizontally gliding installation (the upper run of the chain glides on the lower run).

The gliding shoes are set onto the side links on the inside bend (no tools necessary). Therefore, the chain does not glide on the side links of the chain but only on the gliding shoes. Depending on the application, the service life of the energy chain may be extended five-fold, by using gliding shoes.

The gliding shoes can be optionally equipped with the EVOCONTROL® wear indicator. This indicates the on-time replacement of the gliding shoes.

Type	Order No.	Description	Installation site	Min. radius mm	Gliding shoe height mm
GS 560 gliding shoe	056090400300	Gliding shoe	Inside bend	150.0	6.0
GS 560 gliding shoe EVOCONTROL®	0560400350	Gliding shoe with wear control indicator	Inside bend	150.0	6.0

EVOSILENCE® DAMPING ELEMENT IN SIDE LINK



Damping element in side link

The EVOSILENCE® damping element is an extremely durable noise damping system in the chain link, which functions through a specially developed TPE (thermoplastic elastomer) (optional).

Due to the large area and almost wear-free damping element in the chain link, the energy chains roll up to 10 dB(A) quieter.

Type	Order No.	Description
Damping element MP 560	800099131284	Damping element

EVOSHOX® DAMPING SHOE DS 560



Damping shoe in outside bend

The EVOSHOX® damping shoes significantly reduce the noise emission when the energy chain is rolling.

When using the EVOSILENCE® damping elements in the chain link in connection with the EVOSHOX® damping shoes, the noise emission is reduced by up to 25 dB (A).

Type	Order No.	Description	Installation site	Min. radius mm	Damping shoe height mm
DS 560 damping shoe EVOSHOX®	0560400450	Damping shoe	Outside bend	135.0	5.0
Distance plate for damping shoe DS 560	056090400410	Distance plate	Chain bracket outside bend		

SHELF RB-K

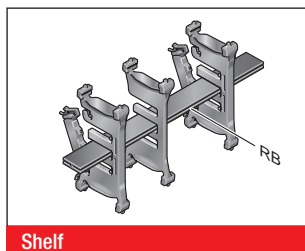

In combination with at least two shelf supports that can be opened on both sides, the shelf provides the innovative EVORACK® shelf support system.

The additional levels prevent the cables from twisting and minimise the friction between them.

Type	Order No.	Description	Width mm	Type	Order No.	Description	Width mm	Type	Order No.	Description	Width mm
RB 23-K *	10000002300	Shelf	23	RB 116-K	1000011604	Shelf	116	RB 206-K	1000020604	Shelf	206.4
RB 28-K	1000002804	Shelf	28	RB 118-K	1000011804	Shelf	118.5	RB 208-K	1000020804	Shelf	208.9
RB 31-K	1000003104	Shelf	30.5	RB 121-K	1000012104	Shelf	121	RB 211-K	1000021104	Shelf	211.4
RB 33-K *	10000003300	Shelf	33.1	RB 123-K	100000012300	Shelf	123.5	RB 213-K	1000021304	Shelf	213.9
RB 36-K	1000003604	Shelf	35.6	RB 126-K	1000012604	Shelf	126.1	RB 216-K	1000021604	Shelf	216.4
RB 38-K	1000003804	Shelf	38.1	RB 128-K	1000012804	Shelf	128.6	RB 218-K	1000021804	Shelf	218.9
RB 41-K	1000004104	Shelf	40.6	RB 131-K	1000013104	Shelf	131.1	RB 221-K	1000022104	Shelf	221.4
RB 43-K	1000004304	Shelf	43.1	RB 133-K	1000013304	Shelf	133.6	RB 223-K	1000022304	Shelf	223.9
RB 46-K	1000004604	Shelf	45.6	RB 136-K	1000013604	Shelf	136.1	RB 226-K	1000022604	Shelf	224.4
RB 48-K	1000004804	Shelf	48.1	RB 138-K	1000013804	Shelf	138.6	RB 228-K	1000022804	Shelf	229
RB 51-K	1000005104	Shelf	50.7	RB 141-K	1000014104	Shelf	141.1	RB 231-K	1000023104	Shelf	231.5
RB 53-K	1000005304	Shelf	53.2	RB 143-K	1000014304	Shelf	143.6	RB 233-K	1000023304	Shelf	234
RB 56-K	1000005604	Shelf	55.7	RB 146-K	1000014604	Shelf	146.2	RB 236-K	1000023604	Shelf	235.5
RB 58-K	1000005804	Shelf	58.2	RB 148-K	1000014804	Shelf	148.7	RB 238-K	1000023804	Shelf	239
RB 61-K	1000006104	Shelf	60.7	RB 151-K	1000015104	Shelf	151.2	RB 241-K	1000024104	Shelf	241.5
RB 63-K	1000006304	Shelf	63.2	RB 153-K	1000015304	Shelf	153.7	RB 243-K	1000024304	Shelf	244
RB 66-K	1000006604	Shelf	65.7	RB 156-K	1000015604	Shelf	156.2	RB 246-K	1000024604	Shelf	246.5
RB 68-K	1000006804	Shelf	68.2	RB 158-K	1000015804	Shelf	158.7	RB 248-K	100000024800	Shelf	249.2
RB 71-K	1000007104	Shelf	70.7	RB 161-K	1000016104	Shelf	161.3				
RB 73-K	1000007304	Shelf	73.3	RB 163-K	1000016304	Shelf	163.8				
RB 76-K	1000007604	Shelf	75.8	RB 166-K	1000016604	Shelf	166.3				
RB 78-K	1000007804	Shelf	78.3	RB 168-K	1000016804	Shelf	168.8				
RB 81-K	1000008104	Shelf	80.8	RB 171-K	1000017104	Shelf	171.3				
RB 83-K	1000008304	Shelf	83.3	RB 173-K	1000017304	Shelf	173.8				
RB 86-K	1000008604	Shelf	85.8	RB 176-K	1000017604	Shelf	176.3				
RB 88-K	1000008804	Shelf	88.3	RB 178-K	1000017804	Shelf	178.8				
RB 91-K	1000009104	Shelf	90.9	RB 181-K	1000018104	Shelf	181.3				
RB 93-K	1000009304	Shelf	93.4	RB 183-K	1000018304	Shelf	183.8				
RB 96-K	1000009604	Shelf	95.9	RB 186-K	1000018604	Shelf	186.3				
RB 98-K	1000098804	Shelf	98.4	RB 188-K	1000018804	Shelf	188.8				
RB 101-K	1000010104	Shelf	100.9	RB 191-K	1000019104	Shelf	191.3				
RB 103-K	1000010304	Shelf	103.5	RB 193-K	1000019304	Shelf	193.9				
RB 106-K	1000010604	Shelf	106	RB 196-K	1000019604	Shelf	196.4				
RB 108-K	1000010804	Shelf	108.5	RB 198-K	1000019804	Shelf	198.9				
RB 111-K	1000011104	Shelf	111	RB 201-K	1000020104	Shelf	201.4				
RB 113-K	1000011304	Shelf	113.5	RB 203-K	1000020304	Shelf	203.9				

EVORACK® SHELF SUPPORT WITH FLAP RTT 560

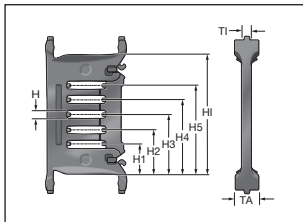

Shelf support

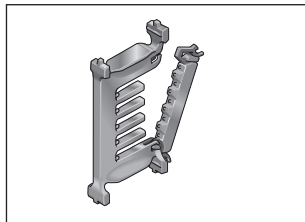

Shelf support

Two shelf supports that can be opened on both sides (RTT) in combination with at least one shelf (RB) provide an easy to fill EVORACK® shelf support system. The additional levels prevent the cables from twisting and minimise the friction between them.

Type	Order No.	Description	Version	TI mm	TA mm	H mm	H1 mm	H2 mm	H3 mm	H4 mm	H5 mm	HI mm
RTT 560 shelf support, with flap	056000004000	Shelf support	lockable	6.0	10.0	3.8	14.2	21.2	28.2	35.2	42.2	56.4

TR 560.1 SEPARATOR

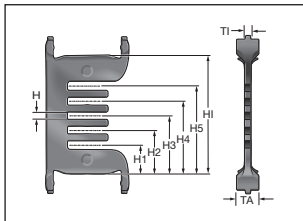

Separator

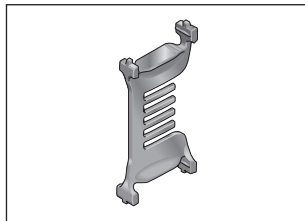

Separator

The lockable separator TR 560.1 is required, when a shelving system with separable shelf supports and shelves is used.

Type	Order No.	Description	Version	TI mm	TA mm	H mm	H1 mm	H2 mm	H3 mm	H4 mm	H5 mm	HI mm
TR 560.1, open, lockable	056000004100	Shelf support	lockable	3.5	10.0	3.8	14.2	21.2	28.2	35.2	42.2	56.4

TR 560.3 SEPARATOR

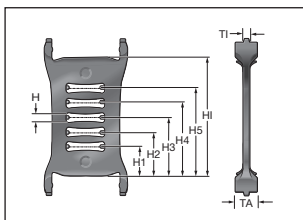

Separator

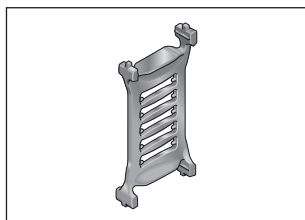

Separator

The lockable separator TR 560.3 is particularly required for gliding applications if only vertical partitions with grids are used.

Type	Order No.	Description	Version	TI mm	TA mm	H mm	H1 mm	H2 mm	H3 mm	H4 mm	H5 mm	HI mm
TR 560.3 lockable	056000004300	Shelf support	lockable	3.5	10.0	3.8	14.2	21.2	28.2	35.2	42.2	56.4

SEPARATOR TR 560.5-V

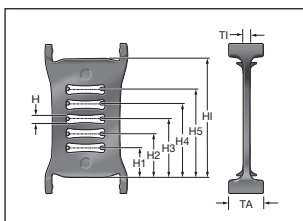

Separator

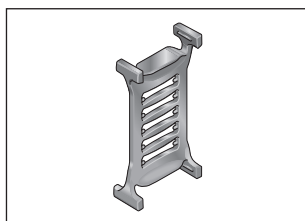

Separator

With the movable separator TR 560.5 uniform chamber widths can be created using the width of the foot contour (dimension TA).

Type	Order No.	Description	Version	TI mm	TA mm	H mm	H1 mm	H2 mm	H3 mm	H4 mm	H5 mm	HI mm
TR 560.5-V, movable	056000004500	Shelf support	movable	3.5	18.0	3.8	14.2	21.2	28.2	35.2	42.2	56.4

MP 560 OPEN

STRAIN RELIEF WITH C-RAIL AND STRAIN RELIEF PLATE ZL-C

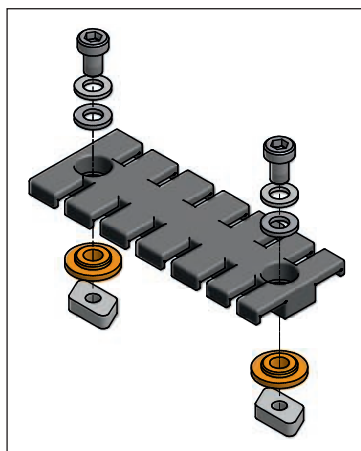

ZL-C set

In addition to a type ZL strain relief plate, the ZL-C sets contain a complete set of installation materials, such as washers, serrated and spacer washers, plus slot nuts for installation in the C-rail.

Suitable combinations of C-rails and ZL-Sets for all inside widths: See table on next page.

Type	Order No.	Version	Quantity teeth
ZL-C 39 Set	87702810	Metric thread	3
ZL-C 60 Set	87702812	Metric thread	4
ZL-C 80 Set	87702814	Metric thread	6
ZL-C 87 Set	87702816	Metric thread	6
ZL-C 103 Set	87702818	Metric thread	7
ZL-C 121 Set	87702820	Metric thread	8
ZL-C 140 Set	87702822	Metric thread	9

STRAIN RELIEF WITH C-RAIL AND STRAIN RELIEF PLATE ZL-C

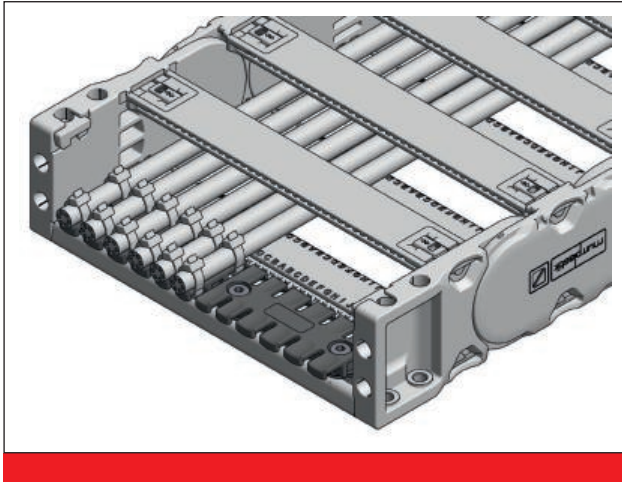

For the strain relief with C-rail and strain relief plate ZL-C the C-rail for the suitable inside width must be chosen. One C-rail per chain bracket side is required.

The combination of the ZL-C for each inner width is shown in the table below. The corresponding order numbers can be found on the previous page.

Type C-rail	Order No.	Inside width mm	Length C-rail mm	Recommended ZL combinations	Quantity teeth
C-rail KA EVOCHAIN® 065	0420065090	65.0	68.0	ZL-C 39	3
C-rail KA EVOCHAIN® 075	0420075090	75.0	78.0	ZL-C 60	4
C-rail KA EVOCHAIN® 087	0420087090	87.0	90.0	ZL-C 60	4
C-rail KA EVOCHAIN® 100	0420100090	100.0	103.0	ZL-C 87	6
C-rail KA EVOCHAIN® 112	0420112090	112.0	115.0	ZL-C 87	6
C-rail KA EVOCHAIN® 125	0420125090	125.0	128.0	ZL-C 103	7
C-rail KA EVOCHAIN® 137	0420137090	137.0	140.0	ZL-C 121	8
C-rail KA EVOCHAIN® 150	0420150090	150.0	153.0	ZL-C 121	8
C-rail KA EVOCHAIN® 162	0420162090	162.0	165.0	ZL-C 140	9
C-rail KA EVOCHAIN® 169	0420169090	169.0	172.0	ZL-C 140	9
C-rail KA EVOCHAIN® 175	0420175090	175.0	178.0	ZL-C 140	9
C-rail KA EVOCHAIN® 182	0420182090	182.0	185.0	ZL-C 80 + ZL-C 80	12
C-rail KA EVOCHAIN® 187	0420187090	187.0	190.0	ZL-C 80 + ZL-C 80	12
C-rail KA EVOCHAIN® 200	0420200090	200.0	203.0	ZL-C 87 + ZL-C 87	12
C-rail KA EVOCHAIN® 207	0420207090	207.0	210.0	ZL-C 103 + ZL-C 87	13
C-rail KA EVOCHAIN® 212	0420212090	212.0	215.0	ZL-C 103 + ZL-C 87	13
C-rail KA EVOCHAIN® 225	0420225090	225.0	228.0	ZL-C 103 + ZL-C 103	14
C-rail KA EVOCHAIN® 237	0420237090	237.0	240.0	ZL-C 121 + ZL-C 87	14
C-rail KA EVOCHAIN® 250	0420250090	250.0	253.0	ZL-C 140 + ZL-C 87	15
C-rail KA EVOCHAIN® 262	0420262090	262.0	265.0	ZL-C 121 + ZL-C 121	16
C-rail KA EVOCHAIN® 275	0420275090	275.0	278.0	ZL-C 121 + ZL-C 121	16
C-rail KA EVOCHAIN® 287	0420287090	287.0	290.0	ZL-C 140 + ZL-C 121	17
C-rail KA EVOCHAIN® 300	0420300090	300.0	303.0	ZL-C 140 + ZL-C 140	18
C-rail KA EVOCHAIN® 312	0420312090	312.0	315.0	ZL-C 121 + ZL-C 80 + ZL-C 80	20
C-rail KA EVOCHAIN® 325	0420325090	325.0	328.0	ZL-C 121 + ZL-C 87 + ZL-C 87	20
C-rail KA EVOCHAIN® 337	0420337090	337.0	340.0	ZL-C 103 + ZL-C 103 + ZL-C 103	21
C-rail KA EVOCHAIN® 350	0420350090	350.0	353.0	ZL-C 121 + ZL-C 121 + ZL-C 80	22
C-rail KA EVOCHAIN® 362	0420362090	362.0	365.0	ZL-C 121 + ZL-C 121 + ZL-C 87	22
C-rail KA EVOCHAIN® 375	0420375090	375.0	378.0	ZL-C 121 + ZL-C 121 + ZL-C 103	23
C-rail KA EVOCHAIN® 387	0420387090	387.0	390.0	ZL-C 121 + ZL-C 121 + ZL-C 121	24
C-rail KA EVOCHAIN® 400	0420400090	400.0	403.0	ZL-C 140 + ZL-C 140 + ZL-C 87	24

STRAIN RELIEF MP STEEL FIX

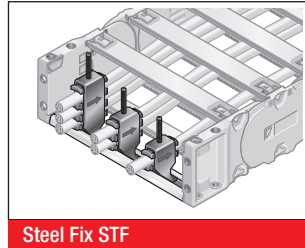
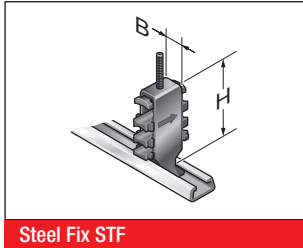

The Steel Fix bow clamps are installed in the chain brackets by means of permanently integrated C-rails (galvanised). They can take up to 3 cables and are suitable for C-rails with a groove width of 11 mm. Due to the design of the channel elements, a cable-friendly fixing of the cables is guaranteed.

The Steel Fix bow clamps can be mounted on both chain ends in the inside and outside bend. The indication of the total height is a guideline value. The actual height depends, among other things, on the cable diameter and cable type. A safety distance of 10 mm at the fixed point above the strain relief must be kept for gliding applications.

Type	Order No.	Description	Holders pcs.	Cable Ø mm	Width (B) mm	Total height (H) mm
Single clamp (for one cable)						
STF MP 12-1 Steel Fix	80661801	Bow clamp	1	6.0 – 12.0	16.0	53.0
STF MP 14-1 Steel Fix	80661802	Bow clamp	1	12.0 – 14.0	18.0	52.0
STF MP 16-1 Steel Fix	80661803	Bow clamp	1	14.0 – 16.0	20.0	54.0
STF MP 18-1 Steel Fix	80661804	Bow clamp	1	16.0 – 18.0	22.0	56.0
STF MP 20-1 Steel Fix	80661805	Bow clamp	1	18.0 – 20.0	24.0	59.0
STF MP 22-1 Steel Fix	80661806	Bow clamp	1	20.0 – 22.0	26.0	61.0
STF MP 26-1 Steel Fix	80661807	Bow clamp	1	22.0 – 26.0	30.0	70.0
STF MP 30-1 Steel Fix	80661808	Bow clamp	1	26.0 – 30.0	34.0	74.0
STF MP 34-1 Steel Fix	80661809	Bow clamp	1	30.0 – 34.0	38.0	78.0
STF MP 38-1 Steel Fix	80661810	Bow clamp	1	34.0 – 38.0	42.0	82.0
STF MP 42-1 Steel Fix	80661811	Bow clamp	1	38.0 – 42.0	46.0	87.0
Double clamp (for two cables)						
STF MP 12-2 Steel Fix	80661821	Bow clamp	2	6.0 – 12.0	16.0	73.0
STF MP 14-2 Steel Fix	80661822	Bow clamp	2	12.0 – 14.0	18.0	74.0
STF MP 16-2 Steel Fix	80661823	Bow clamp	2	14.0 – 16.0	20.0	81.0
STF MP 18-2 Steel Fix	80661824	Bow clamp	2	16.0 – 18.0	22.0	85.0
STF MP 20-2 Steel Fix	80661825	Bow clamp	2	18.0 – 20.0	24.0	89.0
STF MP 22-2 Steel Fix	80661826	Bow clamp	2	20.0 – 22.0	26.0	93.0
STF MP 26-2 Steel Fix	80661827	Bow clamp	2	22.0 – 26.0	30.0	108.0
STF MP 30-2 Steel Fix	80661828	Bow clamp	2	26.0 – 30.0	34.0	119.0
STF MP 34-2 Steel Fix	80661829	Bow clamp	2	30.0 – 34.0	38.0	127.0
Triple clamp (for three cables)						
STF MP 12-3 Steel Fix	80661841	Bow clamp	3	6.0 – 12.0	16.0	97.0
STF MP 14-3 Steel Fix	80661842	Bow clamp	3	12.0 – 14.0	18.0	98.0
STF MP 16-3 Steel Fix	80661843	Bow clamp	3	14.0 – 16.0	20.0	104.0
STF MP 18-3 Steel Fix	80661844	Bow clamp	3	16.0 – 18.0	22.0	111.0
STF MP 20-3 Steel Fix	80661845	Bow clamp	3	18.0 – 20.0	24.0	118.0
STF MP 22-3 Steel Fix	80661846	Bow clamp	3	20.0 – 22.0	26.0	124.0

All details given in our sales brochures and catalogues, as well as the information available online, are based on our current knowledge of the products described.

The electronic data and files made available by Murrplastik, particularly CAD files are based on our current knowledge of the product described.

A legally binding assurance of certain properties or the suitability for a certain purpose can not be determined from this information.

All information with respect to the chemical and physical properties of Murrplastik products, as well as application advice given verbally, in writing or by tests, is given to the best of our knowledge.

They do not release the buyer from the obligation to carry out his own tests and trials in order to determine the concrete suitability of the products for the intended purpose.

Murrplastik accepts no responsibility for the available information being up-to-date, correct or complete. Neither do we accept responsibility for the quality of this information.

Murrplastik accepts no liability for damage caused as a result of using our products.

Murrplastik reserves the right to make technical changes and improvements through constant further development of products and services.

Our General Terms and Conditions apply.

GUIDE CHANNEL VAW (ALUMINIUM / STAINLESS STEEL)

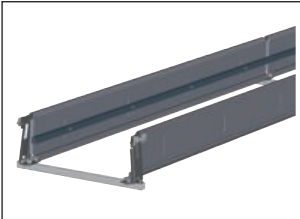

VAW steel galvanised/stainless steel

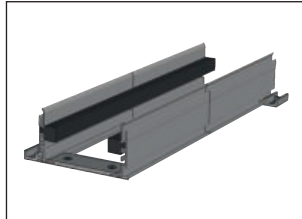

VAW aluminium

A range of variable guide channel systems, constructed from aluminium or stainless steel sections, are available for this energy chain. The variable guide channel ensures that the energy chain is supported and guided securely.

ASSEMBLY

DISASSEMBLY

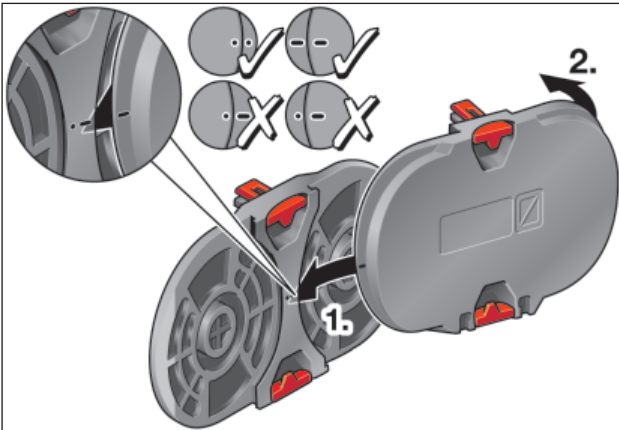

Step 1

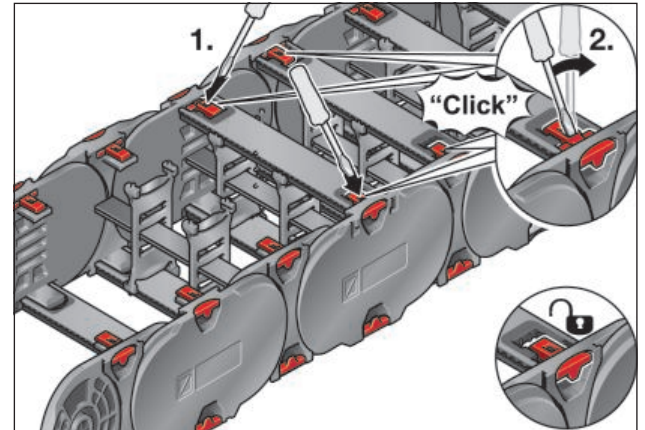

Step 1

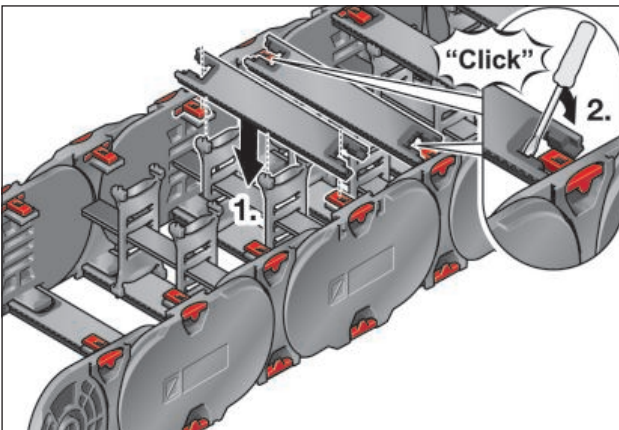

Step 2

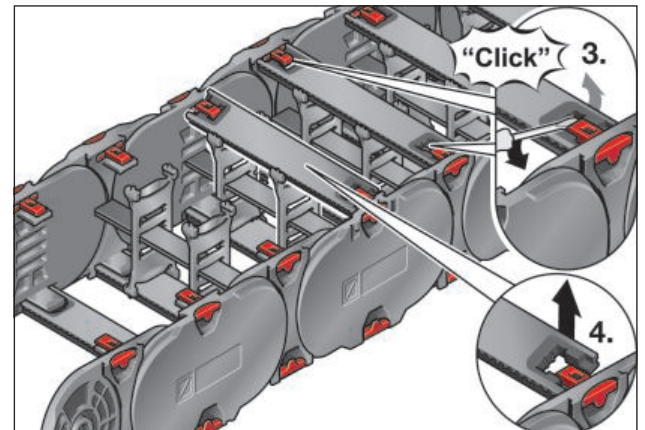

Step 2

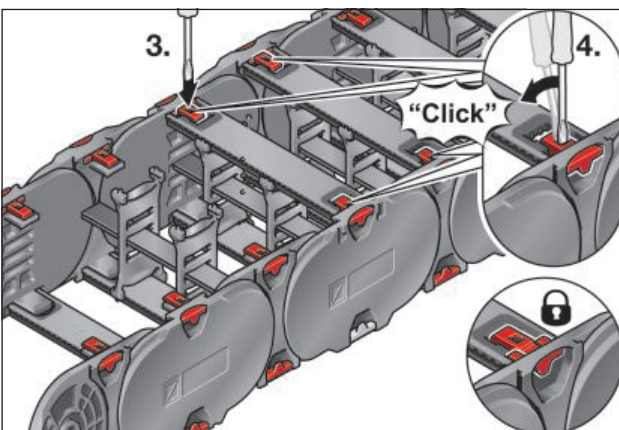

Step 3

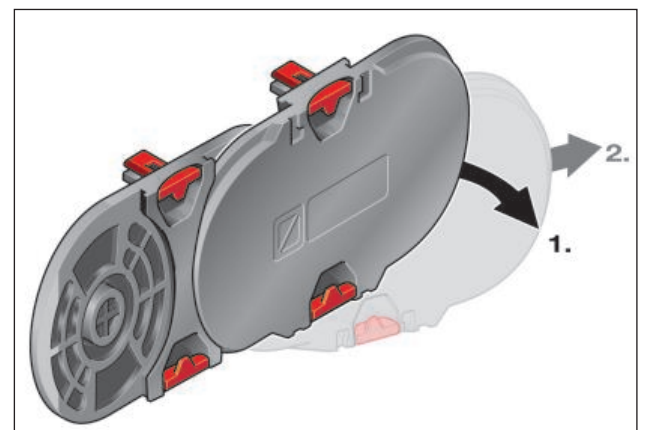

Step 3

MP 560 OPEN

murrplastik



www.mp.de

Germany (Head Office)

Murrplastik Systemtechnik GmbH
Dieselstraße 10
71570 Oppenweiler
☎ +49 7191 4820
www.murrplastik.de
info@murrplastik.de

Americas (North/South)

Murrplastik Systems, Inc.
1175 US Highway 50
Milford, OH 45150
☎ +1 513 201 30 69
www.murrplastik.com
callbackgmt@murrplastik.com

Austria

Murrplastik Systemtechnik GmbH
☎ +43 732 660 870
www.murrplastik.at
info@murrplastik.at

China

Murrplastik Asia Co., Ltd.
1802 Rm. No. 218
Hengfeng Rd.
200070 Shanghai
☎ +86 21 512 869 25
www.murrplastik.com.cn
info@murrplastik.com.cn

Denmark

Filial af Murrplastik
Systemtechnik GmbH Tyskland
Stenager 2
6400 Sønderborg
☎ +45 2347 00 24
www.murrplastik.dk
info@murrplastik.dk

France

Murrplastik S.à.r.l.
Zone industrielle Sud,
6 rue Manurhin B.P. 62
68120 Richwiller
☎ +33 389 570 010
www.murrplastik.fr
info@murrplastik.fr

Italy

Murrplastik Italia S.r.l.
Via Circo, 18
20123 Milano
☎ +39 02 856 805 70
☎ +39 392 3456 456
www.murrplastik.it
info@murrplastik.it

Russia

Офис компании
Murrplastik в Москве
Gilyarovskogo 57, building 1
129110 Moscow
☎ +7 495 684 17 37
www.murrplastik.ru
info@murrplastik.ru

Spain and Portugal

Murrplastik S.L.
Paseo Ubarburu, 76
Pabellón 34, polígono 27
20014 San Sebastián
☎ +34 943 444 837
www.murrplastik.es
info@murrplastik.es

Switzerland

Murrplastik AG
Ratihard 40
8253 Willisdorf
☎ +41 52 646 06 46
www.murrplastik.ch
info@murrplastik.ch

